

OCTAGON

A	B	C
800	75	450
750	75	600
900	75	750

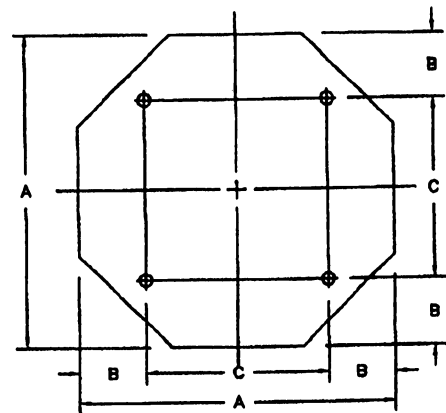

OCTAGON

A	B	C
1200	225	750

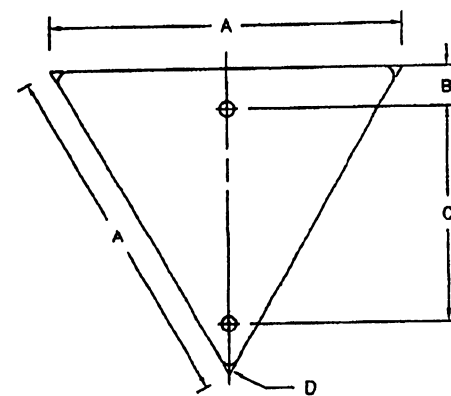

EQUILATERAL TRIANGLE

A	B	C	D
750	75	450	35
900	75	525	50

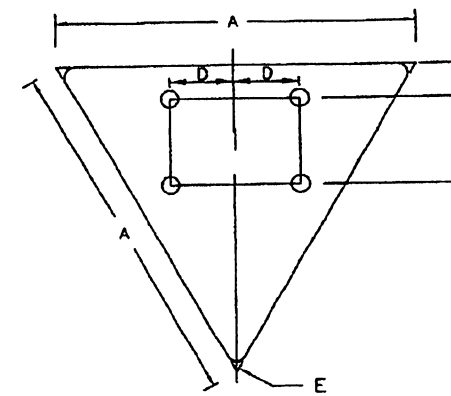

EQUILATERAL TRIANGLE

A	B	C	D	E
1200	75	300	300	75
1500	75	450	375	100

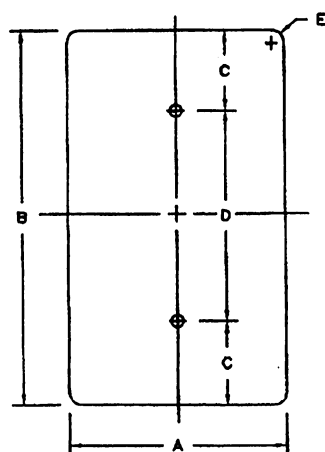

VERTICAL RECTANGLE

A	B	C	D	E
300	450	35	380	35
450	600	75	450	35
600	750	75	600	35
750	900	75	750	45

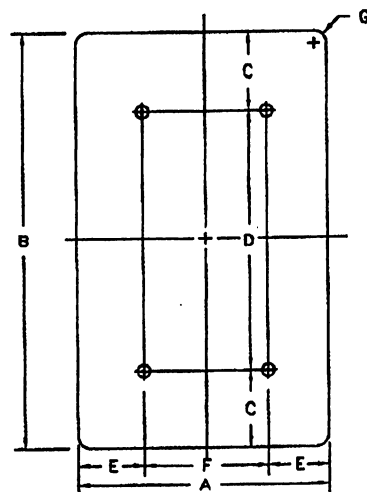

VERTICAL RECTANGLE

A	B	C	D	E	F	G
900	1200	150	900	150	600	55
1200	1500	150	1200	225	750	75

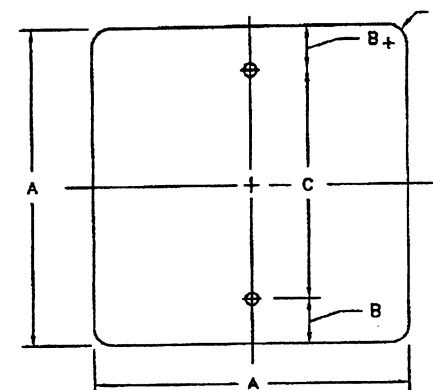

SQUARE

A	B	C	D
450	75	300	35
600	75	450	35
750	75	600	45

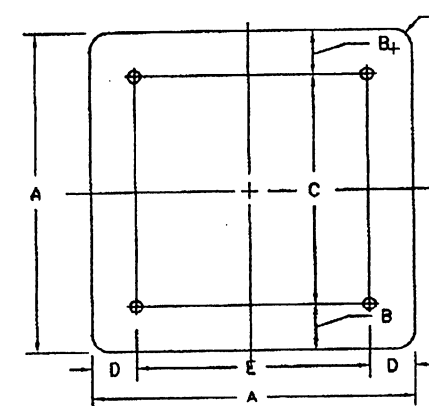

SQUARE

A	B	C	D	E	F
900	150	600	150	600	55
1200	150	900	225	750	75

EFFECTIVE DATE : MAY 1998

COMMONWEALTH OF PUERTO RICO DEPARTMENT OF TRANSPORTATION AND PUBLIC WORKS HIGHWAY AND TRANSPORTATION AUTHORITY		
<p>SMALL TRAFFIC SIGNS BLANK PLATE STANDARDS</p>		<p>RECOMMENDED BY: <i>[Signature]</i> ASST. EXC. DIR. FOR TRAFFIC DATE: 24-11-98</p>
		<p>APPROVED BY: <i>[Signature]</i> EXECUTIVE DIRECTOR DATE: 20-11-98</p>
<p>DATE</p>		<p>APPROVED BY: <i>[Signature]</i> DIV. ADM. FHWA-PR DIVISION DATE: 4-20-98</p>
<p>DATE</p>	<p>REVISION</p>	<p>BY</p>
<p>STD.</p>	<p>STS</p>	<p>DWG. 8 OF 25</p>